

Flexible solar lighting solution for infrastructure-free and remote locations

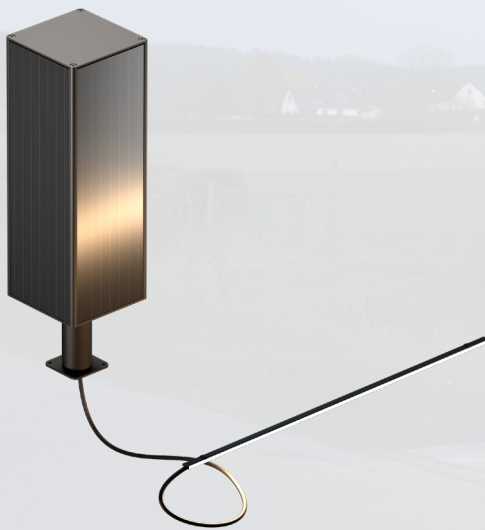

## KEY ADVANTAGES

- > **100% off-grid, zero infrastructure constraints**
- > **Separated solar tower and luminaire architecture allow independent installation, ensuring flexible deployment and seamless integration in off-grid and space-restricted environments.**
- > **Comfortable, continuous linear LED lighting for maximal visibility**
- > **High-performance vertical solar panels for optimum energy capture**
- > **Fast, plug-and-play deployment**

ALTARA LINE provides reliable lighting without the need for electrical infrastructure, unlocking new possibilities for rural and off-grid applications such as bus shelters, kiosks, bicycle parking areas, solar carports, small underpasses and space-restricted locations.

Fully autonomous and grid-free, ALTARA LINE delivers clean, reliable and uniform lighting in locations where traditional infrastructure is difficult or costly to deploy, helping municipalities support the development of sustainable public spaces.

Its decoupled architecture combines a high-efficiency solar tower with a remotely installed linear LED luminaire, offering full flexibility in layout and architectural integration. Equipped with four high-efficiency vertical solar panels, the tower optimises energy capture and can be positioned to maximise solar exposure independently from the lighting area.

Designed to deliver precise, comfortable illumination, ALTARA improves visibility and pedestrian safety while supporting sustainable urban development and reducing operational costs and environmental impact.



## HIGHLIGHTS



Four highly efficient solar panels optimise energy capture throughout the day.

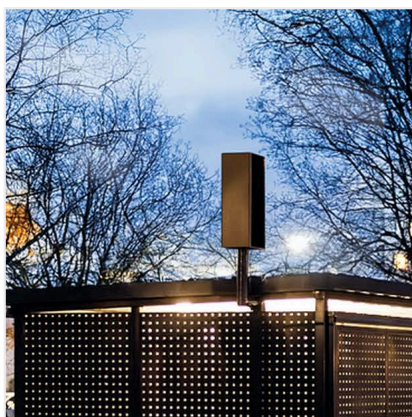

Decoupled architecture allows independent positioning of the solar tower and the LED line for flexible integration in various locations.



Provides reliable, comfortable lighting to enhance safety in infrastructure-free and remote locations.



High capacity battery ensures smart power management throughout the day and night.



Tool-free, coded connectors ensure fast, reliable and error-free installation



Fully integrated electronics simplify installation and accelerate project deployment

ALTARA LINE's separated luminaire gives designers and engineers full spatial freedom. The LED line can be optimally positioned where illumination is needed, not where power is available.

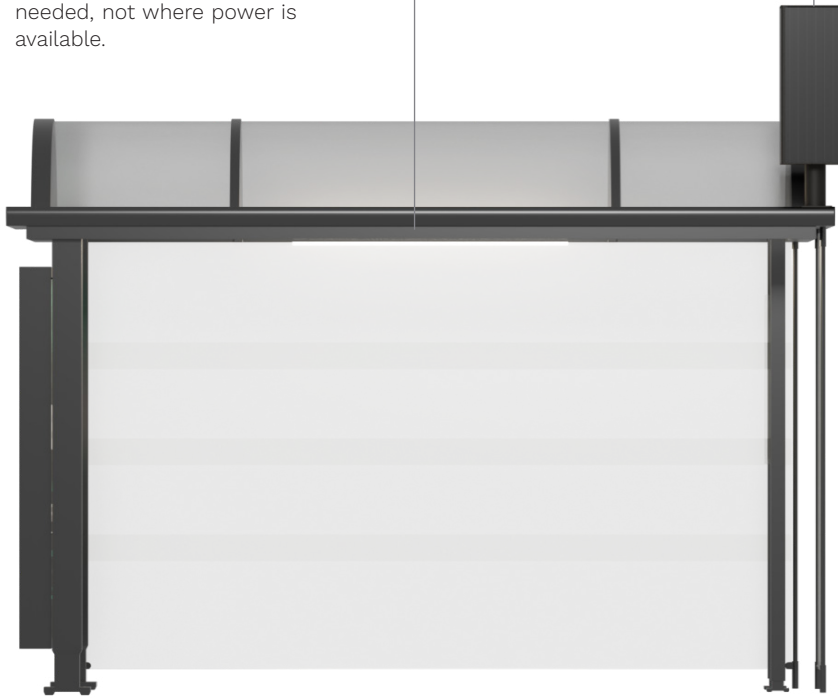

The ALTARA solar tower can be installed on top of or alongside the area to be lit, allowing optimal use of available space while maximising solar exposure.

The vertical solar panels maximise energy capture, even in diffuse light, while preventing snow and dirt buildup for reliable performance in all conditions.

The integrated high-capacity battery provides a smart power management system.

## PRODUCT CONFIGURATION

PRODUCT	ENERGY HARVESTING	ENERGY STORAGE	LUMINAIRE
ALTARA LINE	112Wp	LiFePo4 battery 537Wh	64-LED strip

## DIMENSIONS AND MOUNTING

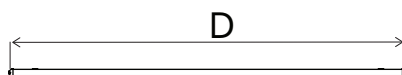
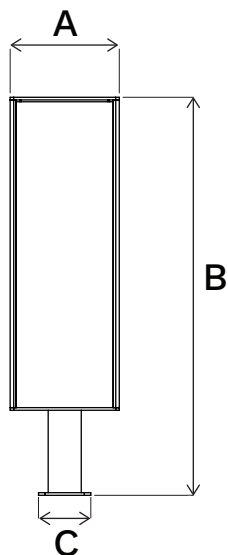

	<b>A</b> (mm   inch)	<b>B</b> (mm   inch)	<b>C</b> (mm   inch)	<b>D</b> (mm   inch)
ALTARA LINE	250   9.8	1102   43.4	120   4.7	1017   40

### ALTARA SOLAR TOWER SURFACE MOUNTING (4x M8 screws)

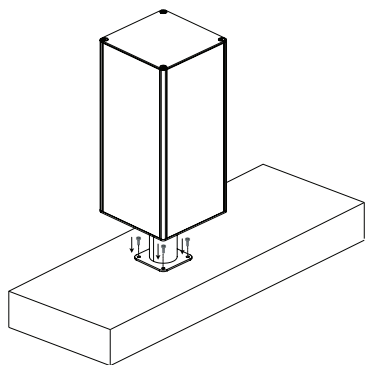

### ALTARA LINE CLIP MOUNTING (2x M4 screws)

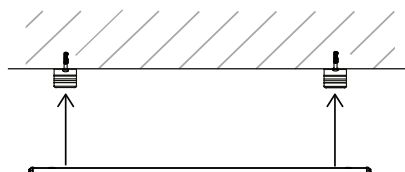

### TOOL-FREE CONNECTION POKE-YOKE CONNECTORS

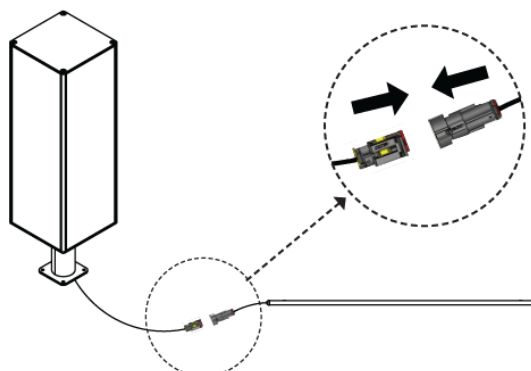

## CHARACTERISTICS

### GENERAL

CE Mark	Yes
Electrical class	Class III EU

### MATERIALS

Housing	Aluminium
Impact resistance	IK 06

### SOLAR TOWER

Finish	Tiger 29/70787 Sparkling Iron Effect Dark
Technology	Monocrystalline silicon cells
Solar cell quantity	44 cells
Frame	Anodised aluminium alloy
Glass	3.2mm (0.13 in) tempered glass
Power	28Wp (x4)
Lifetime expectancy	25 years

### BATTERY

Technology	LiFePo4
Voltage	12.8V
Capacity	537Wh (42Ah)
Operating temperature	-20°C to 60°C   -4°F to 140°F
Autonomy	3 to 5 days
Tightness level	IPX8
Lifetime expectancy	>10 years

### LED LINE

LED colour temperature	3000K (Warm White 930) 6500K (Cool White 965)
Colour rendering index (CRI)	>90
Lifetime of the LEDs @ Tq 25°C	>50,000hrs

## PERFORMANCE

	Luminaire output flux (lm)				Power consumption (W)		Luminaire efficacy (lm/W)
	Warm White WW 930		Cool White CW 965		Min	Max	
Number of LEDs	Min	Max	Min	Max	Min	Max	Up to
64	1200	1200	1300	1300	10	10	134

Tolerance on LED flux is  $\pm 7\%$  and on total luminaire power  $\pm 5\%$

## STANDARD DIMMING PROFILES

**V3: all night 100%**

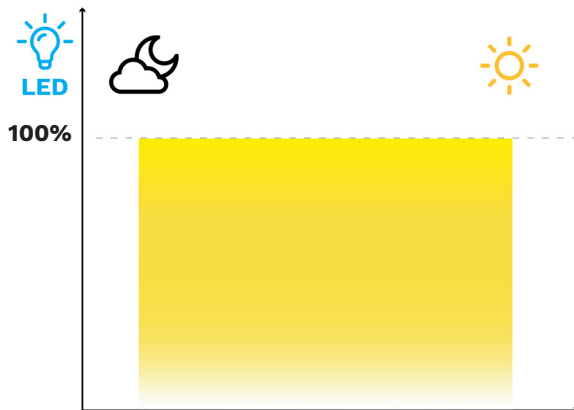

**V4: night dimming to 40%**

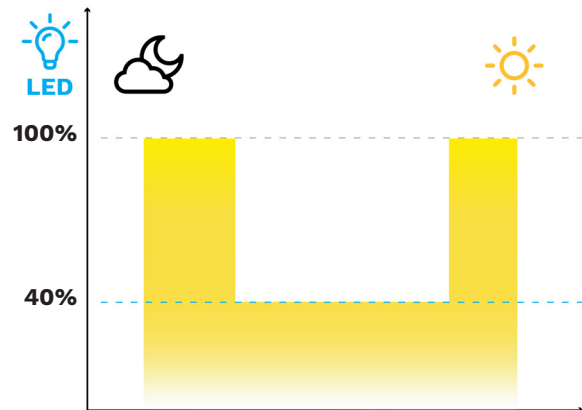

**V5: partial switch OFF**

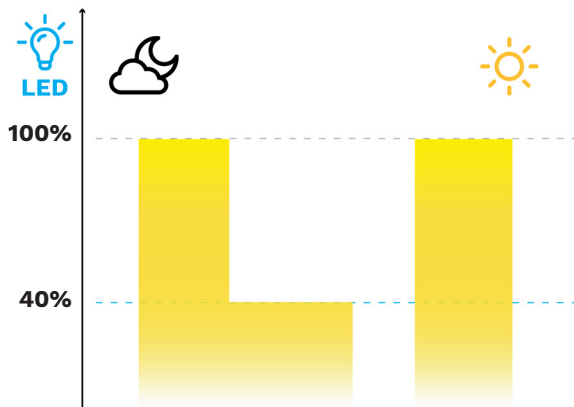

## LIGHT DISTRIBUTIONS

