

Autonomous solar LED bollard for sidewalks, driveways, parks and more



KEY ADVANTAGES

- > **Unobstructed energy absorption: vertical solar panel design prevents blockage by snow and foliage**
- > **Versatile applications: ideal for pavements, driveways, parks and more**
- > **Intelligent controls: automatic day/night detection and customisable dimming programmes**
- > **Robust and durable: high quality components and weatherproof materials ensure longevity**
- > **Easy to deploy: no complex installation, wiring or excavation required**
- > **Customisable configurations: available in 120Wp and 150Wp modules with different mounting options and light distributions**

PREVIA is a state-of-the-art solar-powered bollard that combines advanced technology with elegant design. With its vertically oriented solar panels, PREVIA ensures optimal energy absorption without obstruction from snow or foliage. This innovative design maximises efficiency even in low light conditions, making it a superior choice to conventional solar lights. The PREVIA solar bollard is perfect for a variety of applications including pavements, driveways, pedestrian walkways, parks, boardwalks and promenades, especially in areas without access to electricity.

Available with 120Wp and 150Wp solar panels, the PREVIA range uses high performance photovoltaic technology to charge an integrated battery during the day and power LEDs at dusk. With intelligent controls for day/night detection and different time programmes, PREVIA blends seamlessly into its surroundings, providing reliable and efficient lighting. Its sleek design and customisable RAL colours make it a versatile and aesthetically pleasing solution to any outdoor lighting need. Its robust construction and high quality components ensure longevity and minimal maintenance, providing a cost effective and environmentally friendly lighting solution.



HIGHLIGHTS



High quality finish with perfect integration of vertical photovoltaic panels.



Easy to install with only one toolless coded connector to plug into the top of the housing.



PREVIA is available in two sizes with two solar capacity (120Wp and 150Wp).



The IPX8 LiFePo4 battery offers superior water resistance and reliable performance.

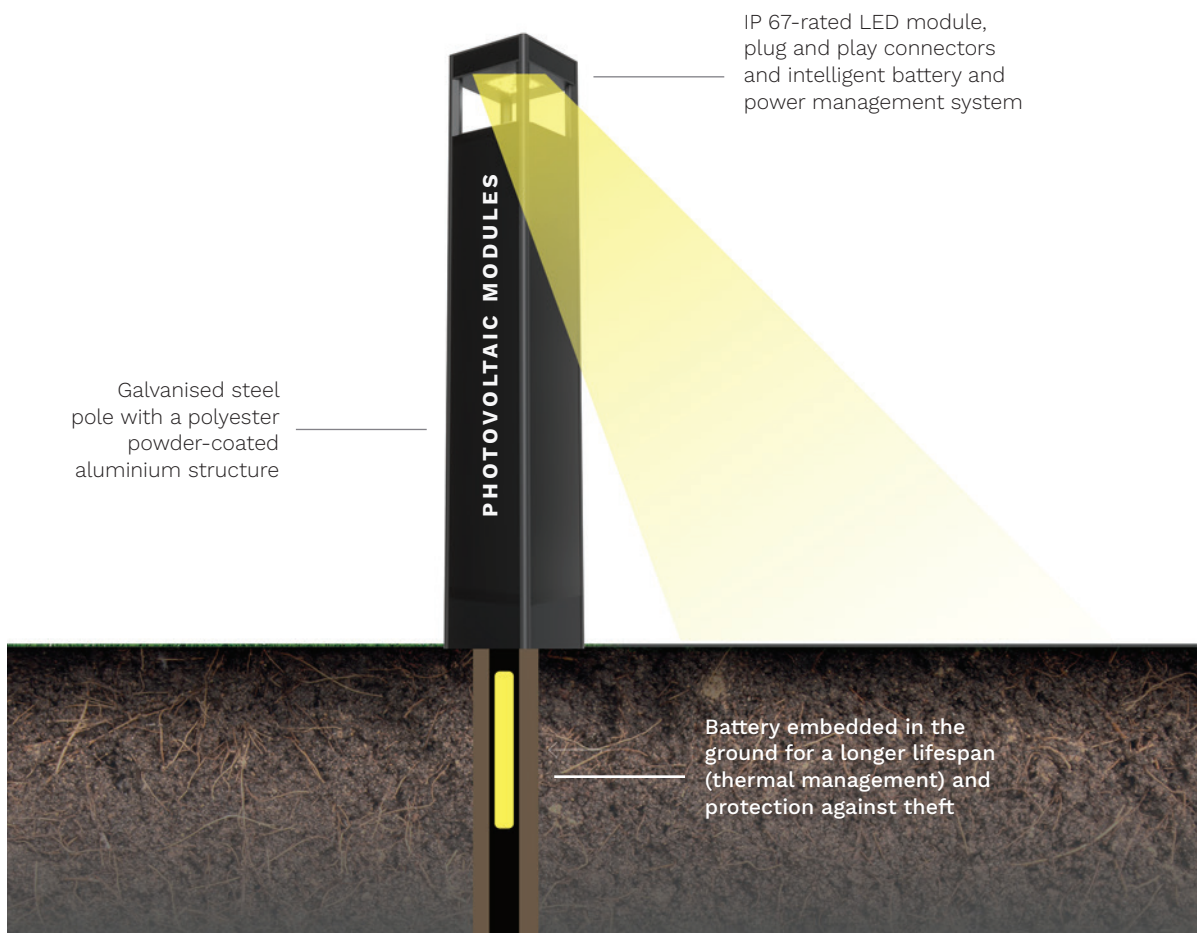

RANGE

	PRODUCT	POLE HEIGHT	ENERGY HARVESTING	ENERGY STORAGE	LUMINAIRE
	PREVIA 120	1200mm 4ft	4x 30W photovoltaic modules	LiFePo4 battery 230Wh	1x 28-LED module
	PREVIA 150	1500mm 5ft	4x 40W photovoltaic modules		

DIMENSIONS AND MOUNTING

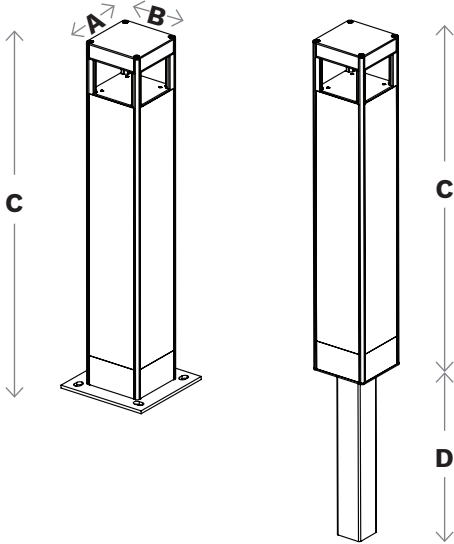

	A (mm inch)	B (mm inch)	C (mm ft)	D (mm inch)
PREVIA 120	176 7	176 7	1200 4	1000 39
PREVIA 150			1500 5	

PIPE FOUNDATION

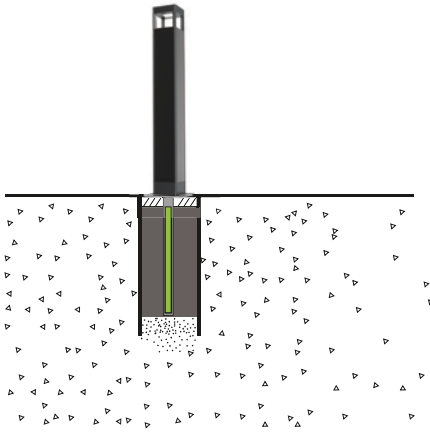

ANCHOR BASE

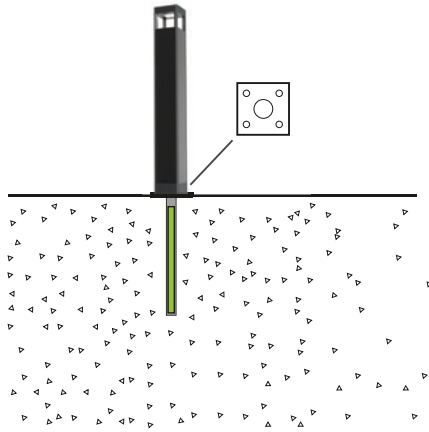

CHARACTERISTICS

GENERAL

CE Mark	Yes
Electrical class	Class III EU

MATERIALS

Pole	Galvanised steel
Metal parts	Aluminium
Finish	Polyester powder coating
Standard colour	RAL 7016M anthracite grey*

Impact resistance IK 06

*any other RAL colour upon request

SOLAR MODULES

Technology	Monocrystalline silicon cells (32 cells per module)
Frame	Anodised aluminium alloy
Glass	3.2mm (0.13 in) tempered glass

Module quantity **PREVIA 120:** 4 modules - 120Wp

PREVIA 150: 4 modules - 150Wp

Electrical characteristics	VOC: 21.9V
	VMPP: 18.5V
	ISC: 2.16A
	IMPP: 2.16A

Lifetime expectancy 25 years

BATTERY

Technology	LiFePo4
Voltage	12.8V
Capacity	230Wh (18Ah)
Operating temperature	-20°C to 60°C -4°F to 140°F
Autonomy	3 to 5 days
Tightness level	IPX8
Lifetime expectancy	>10 years

LED MODULE

Optic/protector	PMMA/PC integrated
Tightness level	IP 67
LED colour temperature	3000K (Warm White 730)
Colour rendering index (CRI)	>70
Upward Light Output Ratio (ULOR)	0%
Upward Light Ratio (ULR)	0%
Lifetime of the LEDs @ Tq 25°C	100,000h - L80

CONTROL

PIR sensor	Optional
Microwave sensor	Optional
Zhaga socket	Optional

PERFORMANCE

	Number of LEDs	Luminaire output flux (lm) Warm White 730		Power consumption (W)		Luminaire efficacy (lm/W)
		Min	Max	Min	Max	Up to
PREVIA 120/150	28	200	3200	2	31	119

Tolerance on LED flux is $\pm 7\%$ and on total luminaire power $\pm 5\%$

LIGHT ON DEMAND

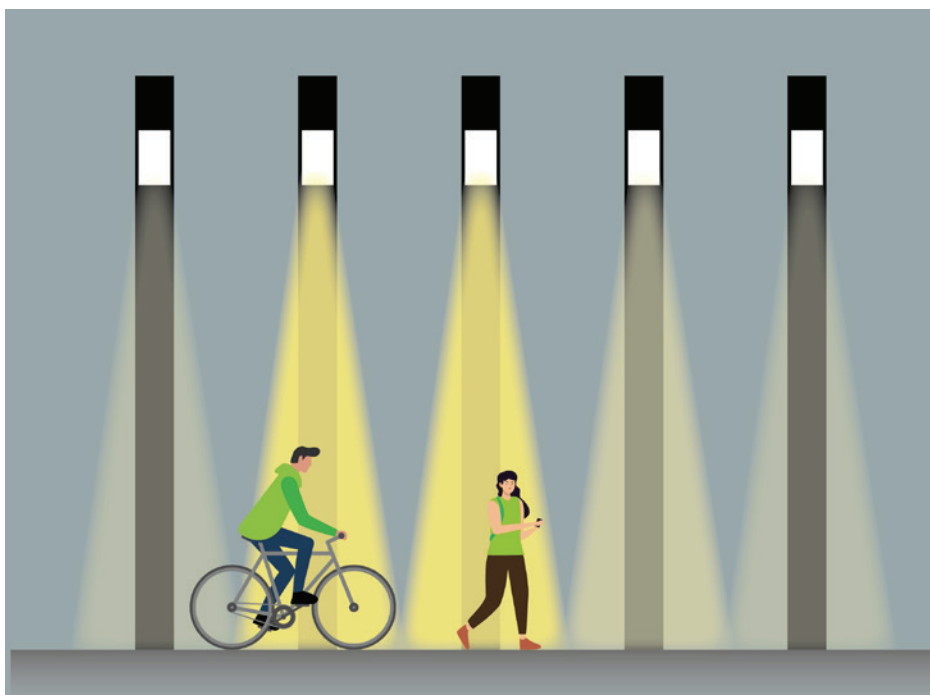

With advanced sensor technology and options for stand-alone operation or bollard-to-bollard local communication, light-on-demand features make a significant contribution to species conservation by actively reducing light pollution. These intelligent bollards provide full light intensity only when needed, ensuring optimum visibility and safety. By dimming the lights during periods of low activity, they prevent over-dimensioning and eliminate the need for additional solar panels and larger batteries, making them an efficient and sustainable solution.

STANDARD DIMMING PROFILES*

V3: all night 100%

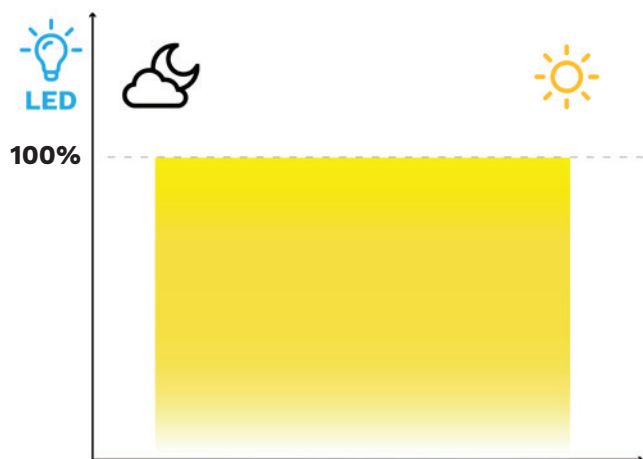

V4: night dimming to 40%

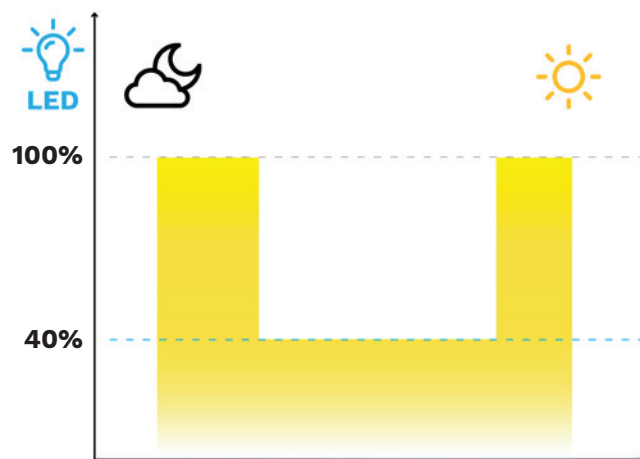

V5: partial switch OFF

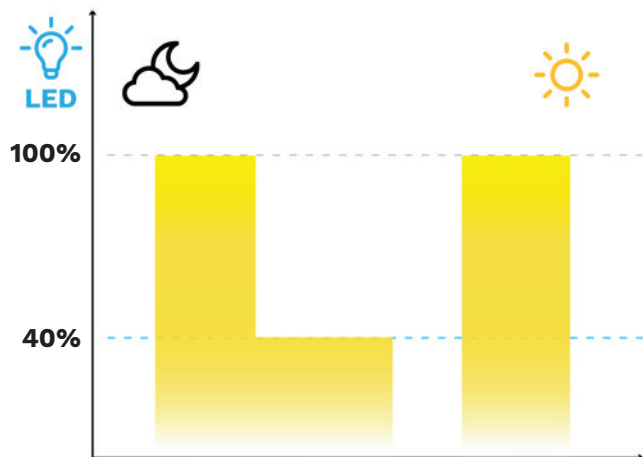

Light on demand (sensor)

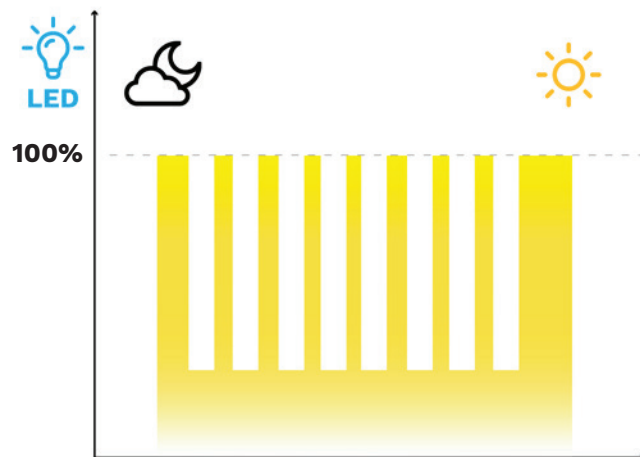

*Customised dimming profiles are available as an option.

LIGHT DISTRIBUTIONS

