

Sylvania AVENUE II



SYLVANIA

Stylish & Effective

The AVENUE II from the SELIGO Range is the LED successor to the Sylvania conventional Avenue series.

The AVENUE II has been invigorated with state-of-the-art design concepts to provide high quality lighting, substantial reductions in operating costs through reduced energy consumption and fewer maintenance requirements.

The decorative shade made from cast aluminium providing greater durability than its predecessors.

IP 66

IK 07

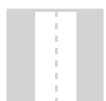

ROADS & MOTORWAYS



URBAN & RESIDENTIAL STREETS



BIKE & PEDESTRIAN PATHS



SQUARES & PEDESTRIAN AREAS



CAR PARKS



LARGE AREAS



RAILWAY STATIONS & METROS

MAIN APPLICATIONS

- Roads and motorways
- Urban and residential streets
- Bike and pedestrian paths
- Squares and pedestrian areas
- Car parks
- Large areas
- Railway stations and metros

KEY ADVANTAGES

- 14 - 22W system watts
- Integral 240V control gear
- Designed specifically to meet Australian/New Zealand Road Lighting Standards, complying with both AS/NZS 60598.2.3 & AS/NZS TS 1158.6
- Optical chamber sealed to IP66 ingress protection
- IK07
- CRI>70
- Ambient temperature -10°C to +40°C
- Available in Colour Temperature of 4000K standard. 2200K & 3000K as options
- Options:
 - Polyester powdercoat finish in various colours
 - NEMA PE base (7 pin) or ZHAGA or combination of both
 - Side or Top entry

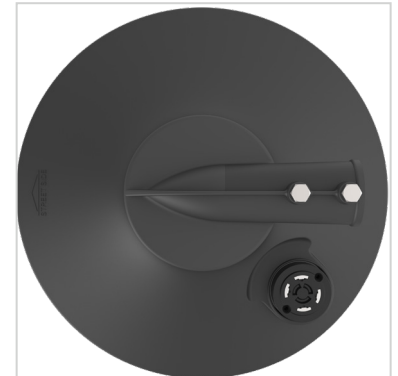

One-piece die cast body with unlimited choice of colours – RAL 7043 is standard



The lens platform is setup using a 50 x 50mm PC tile

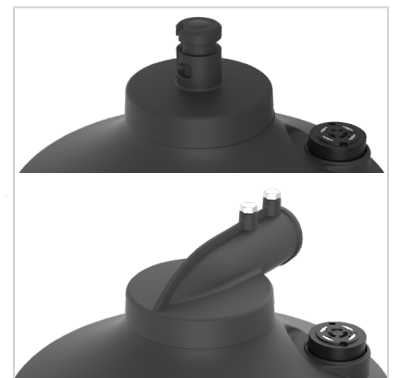

Top or side mounting options available. Flexibility on site



The total luminaire has an impressive IP66 with an IK07 impact rating

SCS is focused on Smart Control technologies, delivering solutions to clients that enable these Smart LED luminaires to become smarter.

The equipped NEMA sockets on the luminaire connects a Smart Light Point Controller/ Node with an easy twist and lock mechanism. The Light Point Controllers enables these luminaires to be connected to a dedicated network and a User-Interface on a computer, which allows these luminaires to be remotely managed.

Key benefits:



Constant Light Output (CLO)

Additional energy savings (over 20%) by using the Constant Light Output (CLO) and Virtual Light Output (VLO) functionality



Dimming schedules

Reducing the amount of light when not required, thereby reducing light glow as well as get further energy savings



Pro-active maintenance

The system reports errors and failures as they occur, helping to repair/ restore the luminaires pro-actively



Smart City devices

Connect additional Smart City devices including Air-quality monitors, Noise sensors, Motion sensors etc



For more information on smart controls contact: info@scs-schreder.com

GENERAL INFORMATION

Recommended installation height	4m to 7.5m 13' to 25'
FutureProof	Easy replacement of the photometric engine and electronic assembly on-site
Driver included	Yes
RCM Mark	Yes
ROHS compliant	Yes
Testing standard	EMC compliant: AS/NZS CISPR15 Luminaires Performance: AS/NZS 60598.1 & AS/NZS 60598.2.3 Lighting for Roads and Public Spaces: SA/SNZ TS 1158.6

HOUSING AND FINISH

Housing	Die-cast aluminium body
Optic	Polycarbonate
Protector	Tempered glass
Housing finish	Polyester texture finish
Standard colour(s)	RAL 7043 Any other colour on request
Tightness level	IP66
Impact resistance	IK07
Access for maintenance	Toolless

PERFORMANCE

Lumen efficacy	140lm/w
----------------	---------

ELECTRICAL INFORMATION

Electrical class	Class 1 or Class 2
Nominal voltage	240v – 50Hz/60Hz
Power factor (at full load)	> 0.9
Surge protection options (kV)	10kV
Electromagnetic compatibility (EMC)	AS/NZS CISPR15
Control protocol(s)	DALI
Socket(s)	NEMA 7 pin
Sensor(s)	Devices & sensors for smart city applications

OPTICAL INFORMATION

LED colour temperature	4000K (2200K & 3000K optional)
Colour rendering index (CRI)	> 70
Upward Light Output Ratio (ULOR)	0%

OPERATING CONDITIONS

Temperature range from operation (Ta)	-10°C to +40°C
---------------------------------------	----------------

(*) Depending on the configuration of the luminaire. For more details, contact us.

DIMENSIONS AND MOUNTING

W x H x D (mm)	450 x 450 x 240
Weight (kg)	7
Mounting possibilities	Side entry: 27mm - 34mm OD Top Entry: J-hook coupling as per AS/NZS1158:2015

TOP VIEW
AVENUE II(SIDE MOUNT)

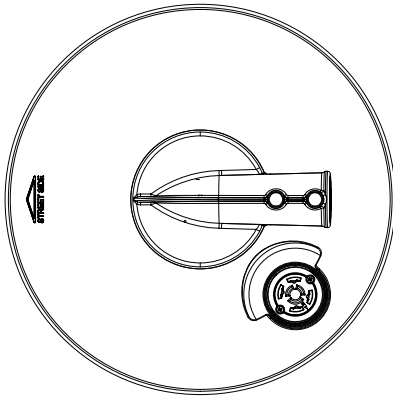

TOP VIEW
AVENUE II(TOP MOUNT)

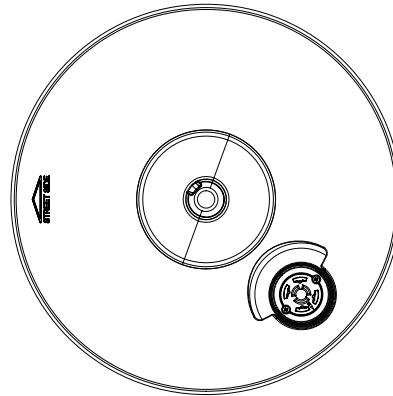

FRONT VIEW
AVENUE II(SIDE MOUNT)

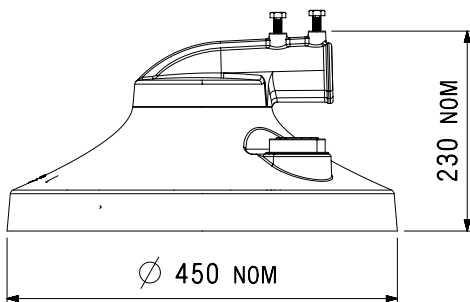

FRONT VIEW
AVENUE II(TOP MOUNT)

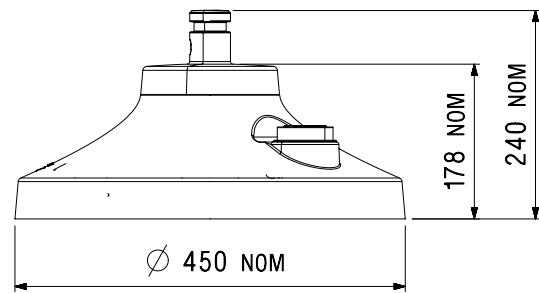

BOTTOM VIEW
AVENUE II

